

Data Sheet

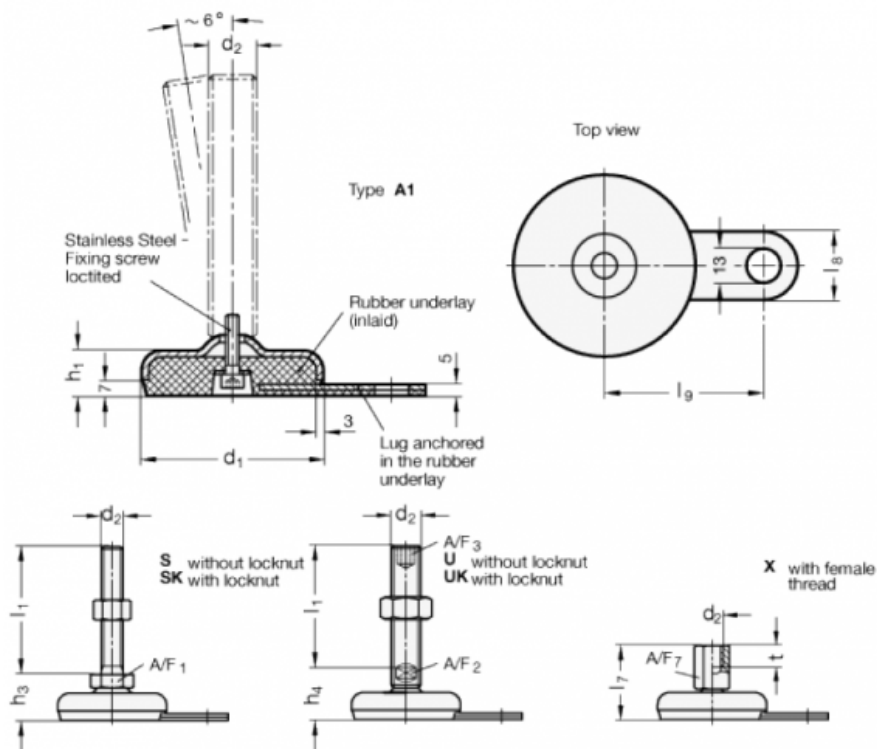

Article number: 203280M1249A1X
 Description: E+G levelling foot
 GN 32-80-M12-49-A1-X
 Note: X With female thread, External hexagon

Measures



A/F7	=	17
d1	=	80
d2	=	M12
h1	=	20
l7	=	49
l8	=	30
l9	=	70
t	=	12